

PRODUCT INSTALLATION GUIDE

MODEL: 4WD Heavy Duty System
PRODUCT CODE: 4WDHDSFK
PRODUCT DESCRIPTION: CouplerTec Electronic Rustproofing System 12V
Four Capacitive Couplers

KIT CONTENTS:

ITEM	QTY	ITEM	QTY	ITEM	QTY
Couplertec Module	1	Heat Shrink Connector	7	Alcohol Cleaning Pad	4
Capacitive Coupler	4	Small Ring Terminal 5mm	1	Black Auto Cable 7m	2
Fuse Holder	1	6mm Hex Nut	1	Split Loom 3m	1
Fuse (2Amp)	1	Self - Tapping Screw	2	Cable Ties	20

When installing the Couplertec Electronic Rustproofing System, you will need:

PRODUCT REQUIRED

1. Neutral Cure Silicone (if needed)

TOOLS REQUIRED:

1. Wire Stripper
2. Crimping Tool
3. Side Cutter
4. Shifting Spanner
5. 4mm Drill Bit
6. 2mm Drill Bit
7. Power Drill
8. Heat Gun or Gas Torch

Installation Guide Video



<http://bit.ly/1iWi9XN>

PLEASE READ THE FOLLOWING FITTING INSTRUCTIONS CAREFULLY BEFORE PROCEEDING TO INSTALL THE COUPLERTEC ELECTRONIC RUSTPROOFING SYSTEM.

For **technical support** please contact us
from **7 AM to 4 PM CET** on **business days** (Monday to Friday)
by **phone 00 386 40 80 33 40** or
send us an e-mail to **info@couplertec.si**.

No question will remain unanswered.

Step 1: Select a site to locate the Couplertec Module

The Module should be mounted within the engine bay on either the firewall or guard, preferably on the same side as the vehicles main/start battery. The Module can be mounted either horizontally or vertically. Try and locate the Module in a site that will not interfere with normal vehicle repair or maintenance, and preferably a site where the two LED indicators will be visible. Ensure that there is nothing behind the site that can be damaged by the self-tapping screws which will be used to secure the Module to the vehicle.

Step 2: Selecting sites to locate the Capacitive Couplers

Two Capacitive Coupler should be located at the front of the vehicle on either, the firewall, inner guard or wheel arch within the engine bay (one on the left side, one on the right side).

Two Capacitive Coupler should be located at the rear of the vehicle, preferably on the inner guard behind the tail light assembly (one on the left side, one on the right side). Access to this area can generally be gained by removing the tail light assembly or internal compartment covers.

IMPORTANT INFORMATION: Please ensure that you do not locate Capacitive Couplers within 1m of Radio aerials that are impregnated into the rear side windows of vehicles. For these vehicles we recommend that you locate the rear Capacitive Coupler on the opposite side of the vehicle to where the aerial is located or on the underside of the vehicles body or chassis rail.

For Cab chassis vehicles (with or without a tray), the rear Capacitive Coupler should be fitted to either the left or right hand chassis rail at the rear of the vehicle, alternatively, if the vehicle is a Dual Cab, then the rear Capacitive Coupler can be fitted to the inner rear wall of the cabin.

IMPORTANT INFORMATION: The Capacitive Coupler site must be:

- **A painted metal surface which is part of the vehicles main Body (preferred) or Chassis**
- **Flat (no contoured surfaces or indentations)**
- **Large enough to accommodate the entire surface area of the Capacitive Coupler**
- **Free of holes**
- **Free of joins in the metal work**
- **Free of spot welds, welding slag/spikes**
- **Well painted with no scratches (if in doubt, lightly sand and apply two coats of quick dry enamel paint to the area).**

(FIGURE: 1): Example diagram of a vehicle installation

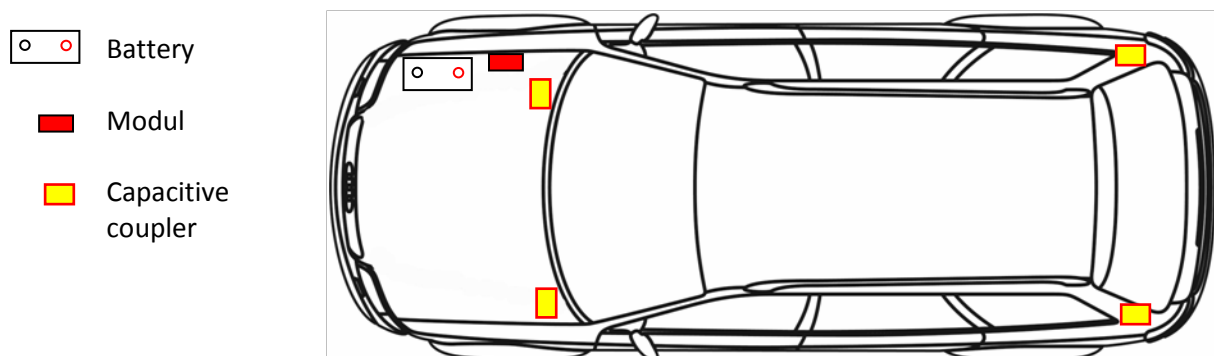

Step 3: Fitting the CouplerTec Module

Drill two 4mm holes in the base wings of the Module for fitting. (refer figures 2 & 3)

(FIGURE: 2)

2 x 4mm Holes for Horizontal

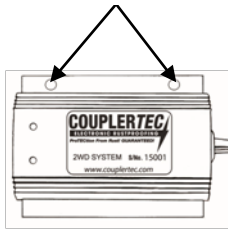

(FIGURE: 3)

2 x 4mm Holes for Vertical

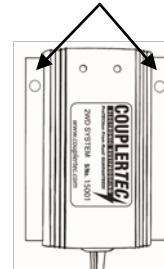

IMPORTANT INFORMATION: The GREEN earth wire (earth) must be connected to the body (metal surface) of the vehicle, the GREEN wire can be earthed under the screw head of one of the self tapping screws which is used to fasten the Module to the vehicles body (refer figure: 4). The earth connection must be a minimum distance of 50cm away from the Capacitive Coupler location. The Green wire can be extended using 4mm auto wire and routed to another suitable earth location if required.

Cut the GREEN wire to length, strip the end of the wire and crimp on the Small Ring Terminal ready to be earthed.

(FIGURE: 4)

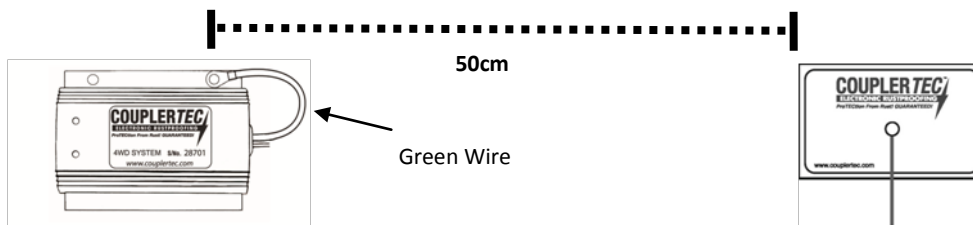

Whilst holding the Module in the selected position for mounting, mark the positions of the 4mm holes on the body of the vehicle for the placement of the self-tapping screws. (refer figure: 5)

Using one of the marked positions, drill a 2mm pilot hole into the body of the vehicle and screw 1 x self-tapping screw into the pilot hole to secure the Module to the car.

Drill the second 2mm pilot hole and place the ring terminal of the GREEN wire under the head of a self-tapping screw, screw to the body of the vehicle.

(FIGURE: 5)

Mark these positions on the vehicle body & drill 2mm pilot holes

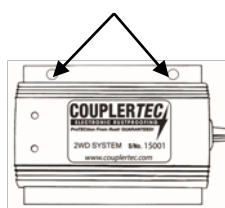

(FIGURE:6)

Self – tapping

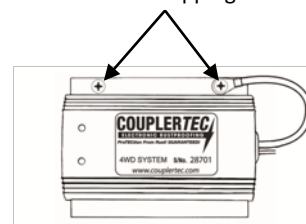

Step 4: Connecting the CouplerTec Module to the vehicles main start battery

IMPORTANT INFORMATION: Do not connect the CouplerTec Module to auxiliary batteries.

Connect the pre-wired half of the fuse holder (the ring terminal) to the positive (+) battery terminal. Do not undo the nut on the battery terminal unless absolutely necessary, if possible, use the supplied 6mm hex nut to screw onto the thread of the battery terminal and tighten up to the existing nut.

Route the RED wire from the Module to the fuse holder, cut to length and crimp to the other half of the fuse holder using a crimp heat-shrink connector. Use a heat gun to seal the heat-shrink connector.

(FIGURE:7)

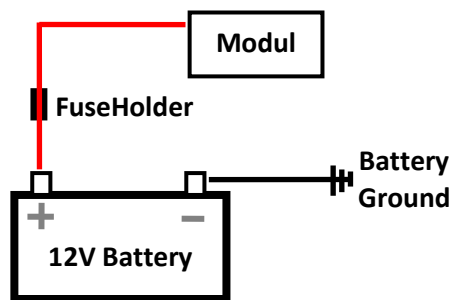

DO NOT INSERT THE FUSE AT THIS STAGE

Step 5: Wiring the FRONT Capacitive Couplers → For each Capacitive Coupler

Route the BLUE wire from the module towards the selected Capacitive Coupler site at the FRONT of the vehicle and cut to length, or extend if necessary using 4mm auto wire.

Make a connection between the BLUE wire (or extended wire) and a Capacitive Coupler using the supplied crimp heat-shrink connector.

Fit the Capacitive Coupler (Refer to “Fitting the Capacitive Coupler” at the end of this document).

Step 6: Wiring the REAR Capacitive Couplers → For each Capacitive Coupler

Route the supplied BLACK wire between the engine bay and the rear Capacitive Coupler site, either internally through the vehicle or under the vehicle via the chassis rail. The wires can be routed together up one side of the vehicle.

Within the engine bay, make a connection between the BLACK wire and of the modules WHITE wires using the supplied crimp heat-shrink connector. After crimping the connection use a heat gun to apply heat to the Heat Shrink Connector to seal the connection.

At the rear Capacitive Coupler site, make a connection between the BLACK wire and a Capacitive Coupler using the supplied crimp heat-shrink connector. After crimping the connection use a heat gun to apply heat to the Heat Shrink Connector to seal the connection.

Fit the Capacitive Coupler (Refer to “Fitting the Capacitive Coupler” at the end of this document).

IMPORTANT INFORMATION: Run all wiring along the sides of your engine compartment. Be sure to avoid positioning wires too close to hot or moving parts that may melt or pinch the wires. When running wiring through the firewall ensure that you use rubber grommets to protect the wiring. Protect all wiring within the engine bay with split loom. Secure all wiring firmly with cable ties. Existing brake or electrical lines can be used to brace the wiring under the vehicle and within the engine bay. Ensure that all wiring joins are crimped and sealed correctly using a heat gun to heat the heat shrink and seal the connection.

Step 7: Check Installation

Check all wiring connections to ensure that they are secure and sealed correctly.

Ensure that the Capacitive Couplers are all affixed to the body/chassis of the vehicle.

Step 8: Insert the fuse

Insert the fuse into the fuse holder and observe the modules LED's to confirm Normal Operation Mode (refer to the below Modes of Operation).

Modes of operation

The CouplerTec Electronic Rustproofing Module has two LEDs which indicate the systems current mode of operation.

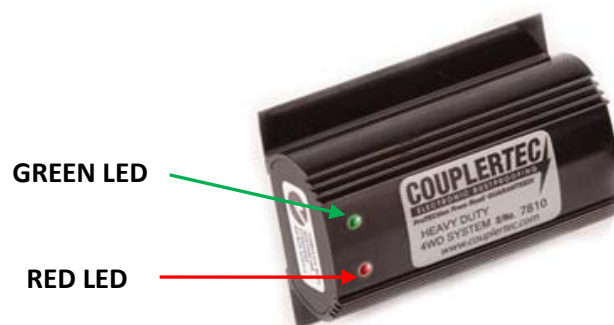

The Module has three modes of operation, which are:

1. Start-up Mode

When the fuse is inserted the modules Green LED will illuminate for 30 seconds whilst the system configures itself.

2. Normal Operation Mode

The modules Green LED will flash continuously confirming that the system is functioning correctly.

3. Fault Mode

The modules Red LED will flash upon the detection of a fault. The fault indicators are:

- Red LED flashing continuously: This indicates that the module has detected a Dead Short and has shut itself down.
- Red & Green LEDs flashing together 10 times every 30 seconds: This indicates Low Battery, meaning that the vehicles battery level has dropped below the minimum input requirement and that the module has shut itself down to protect the battery.

Fitting the Capacitive Coupler

Thoroughly clean the site where the Capacitive Coupler is to be located using the alcohol cleaning pad. Remove any oil, wax or dirt. For extremely dirty sites, use white spirits or similar with a rag to clean the site, followed by the use of the alcohol cleaning pad.

Before affixing the Capacitive Coupler, ensure that all joins between the module and Capacitive Coupler have been completed.

Once the site is clean and dry peel off the backing paper from the back of the Capacitive Coupler ready to secure (don't touch the adhesive surface). The Capacitive Coupler must be affixed in an upright position with the wire facing downwards (refer figure 8), firmly press the Capacitive Coupler onto the prepared site making sure that there are no bubbles under the Capacitive Coupler. The Capacitive Coupler must be 100% in contact with the painted metal surface.

(FIGURE: 8)

IMPORTANT:

DO NOT install the Capacitive Coupler in an upside down position. Always install the Capacitive Coupler with the wire facing towards the ground.

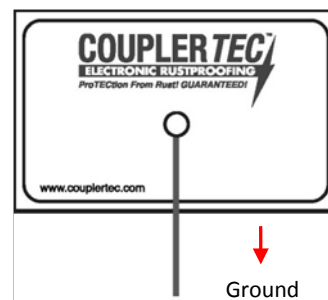

IMPORTANT INFORMATION: If you are locating Capacitive Couplers on the underside of the vehicles body or chassis rails, or other areas that may potentially be exposed to water, then you must:

Completely dome over the entire Capacitive Coupler including the wire with a Neutral Cure Silicone Sealant ensuring that the edges of the Capacitive Coupler are sealed to the paintwork.